

# **Tankzubehör und Armaturen für die Lebensmittel- und Wasserindustrie**

**Ausgabe 2023**





## Inhalt

1. Tankzubehör .....	3
Mannlöcher .....	3
Zubehör für Mannlöcher .....	5
Entlüftungen .....	7
Schaugläser und Tankbeleuchtungen.....	8
Getriebemotoren für Rührwerke.....	9
Ersatzteile zu Getriebemotor .....	10
Rührorgane.....	11
Reinigungsturbinen.....	13
Sprühkugeln .....	14
Stellfüsse / Kalottenteller .....	15
Tankböden.....	16
2. Armaturen für die Lebensmittelindustrie .....	17
DIN Armaturen .....	17
Lebensmittelrohre .....	22
Ventile für Lebensmittel (M&S).....	23
Ersatzteile zu Scheibenventil (M&S).....	24
Ventile für Lebensmittel (Kieselmann).....	26
Ersatzteile zu Scheibenventil (Kieselmann) .....	27
Ventile allgemein.....	28
Eckrohrsieb.....	29
Schmutzfänger .....	29
3. Armaturen für die Wasser- und Abwasserindustrie.....	30
Kugelhähne.....	38
Ausbaustücke.....	39
Expansionsgefässe .....	40
Trinkwasserschlauch.....	41
4. Rohrkonsolen aus Edelstahl, schwere Ausführung.....	42
5. Pumpen .....	45
6. Waschröge und Spültische .....	49

# 1. Tankzubehör

## Mannlöcher

Art.-Nr.: ML-B5						
	Länge (mm)	Breite (mm)	Art.Nr.	CHF / Stk. 1.4301	Art.Nr.	CHF / Stk. 1.4404
		420	310	10301	1'483.-	10302

Art.-Nr.: ML-B2						
	Länge (mm)	Breite (mm)	Art.Nr.	CHF / Stk. 1.4301	Art.Nr.	CHF / Stk. 1.4404
		530	410	10303	1'965.-	10304

Art.-Nr.: ML-A7						
	Länge (mm)	Breite (mm)	Art.Nr.	CHF / Stk. 1.4301	Art.Nr.	CHF / Stk. 1.4404
		440	310	10305	1'070.-	10306

Art.-Nr.: ML-A9						
	Länge (mm)	Breite (mm)	Art.Nr.	CHF / Stk. 1.4301	Art.Nr.	CHF / Stk. 1.4404
		440	310	10307	910.-	10308

**Art.-Nr.: ML-D8**

	Ø (mm)	Höhe (mm)	Art.Nr.	CHF / Stk. 1.4301	Art.Nr.	CHF / Stk. 1.4404
	200	90	10401	382.-	10402	450.-
	300	90	10403	503.-	10404	592.-
	420	90	10405	694.-	10406	816.-
	460	90	10407	784.-	10408	922.-
	500	90	10409	844.-	10410	993.-
	600	90	10411	1'030.-	10412	1'212.-

**Art.-Nr.: ML-D9**

	Ø (mm)	Höhe (mm)	Art.Nr.	CHF / Stk. 1.4301	Art.Nr.	CHF / Stk. 1.4404
	300	45/90	10413	462.-	10414	544.-
	360	45/90	10415	512.-	10416	603.-
	385	45/90	10417	553.-	10418	650.-
	420	45/90	10419	627.-	10420	739.-
	460	45/90	10421	697.-	10422	821.-
	500	45/90	10423	764.-	10424	898.-
	600	45/90	10425	1'090.-	10426	1'282.-

➔ Weitere Ausführungen auf Anfrage!

## Zubehör für Mannlöcher

### Art.-Nr.: MLD-D8

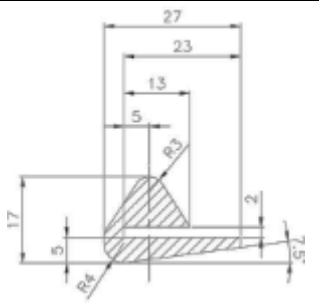
	Werkstoff	Ø (mm)	Temp.bereich °C	Art.Nr.	CHF / Stk.
	Natural Gummi	200 – 600	-35 / +90	10501	110.-
	EPDM	200 – 600	-35 / +110	10502	152.-
	Nitril	200 – 600	-35 / +110	10503	139.-
	Silikon	200 – 600	-35 / +200	10504	187.-
	Viton	200 – 600	-35 / +90	10505	166.-

### Art.-Nr.: MLD-D9

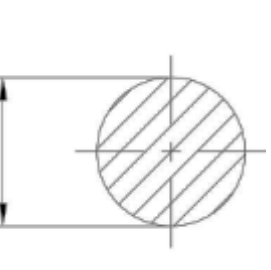
	Werkstoff	Ø (mm)	Temp.bereich °C	Art.Nr.	CHF / Stk.
	Natural Gummi	300 – 600	-35 / +90	10506	110.-
	EPDM	300 – 600	-35 / +110	10507	152.-
	Nitril	300 – 600	-35 / +110	10508	139.-
	Silikon	300 – 600	-35 / +200	10509	187.-
	Viton	300 – 600	-35 / +90	10510	166.-
<b>Dichtungs-Ø je nach Mannlochgrösse unterschiedlich!</b>					

### Art.-Nr.: MLD-A9 / A7

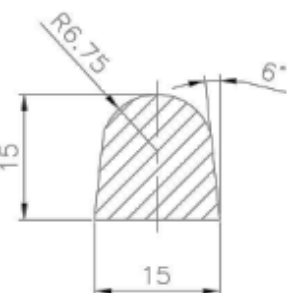
	Werkstoff	Ø (mm)	Temp.bereich °C	Art.Nr.	CHF / Stk.
	Natural Gummi	440 x 310	-35 / +90	10511	110.-
	EPDM	440 x 310	-35 / +110	10512	152.-
	Nitril	440 x 310	-35 / +110	10513	139.-
	Silikon	440 x 310	-35 / +200	10514	187.-
	Viton	440 x 310	-35 / +90	10515	166.-

### Art.-Nr.: MLD-B2 / B5

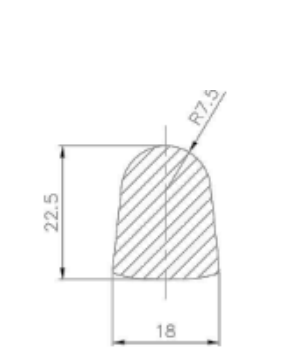
	Werkstoff	Ø (mm)	Temp.bereich °C	Art.Nr.	CHF / Stk.
	Natural Gummi	B2 530 x 420 B5 420 x 310	-35 / +90	10516	110.-
	EPDM	B2 530 x 420 B5 420 x 310	-35 / +110	10517	152.-
	Nitril	B2 530 x 420 B5 420 x 310	-35 / +110	10518	139.-
	Silikon	B2 530 x 420 B5 420 x 310	-35 / +200	10519	187.-
	Viton	B2 530 x 420 B5 420 x 310	-35 / +90	10520	166.-

**Art.: Sterngriff gross**

	Werkstoff	Ø (mm)	Gewinde	Art.Nr.	CHF / Stk.
	Nylon	90	M18 x 1.5	10601	<b>48.-</b>

**Art.: Sterngriff klein**

	Werkstoff	Ø (mm)	Gewinde	Art.Nr.	CHF / Stk.
	Nylon	70	M12	10602	<b>35.-</b>
	<b>Mit Durchgangsloch!</b>				

**Art.: Handrad**

	Werkstoff	Ø (mm)	Gewinde	Art.Nr.	CHF / Stk.
	Nylon	160	M18 x 1.5	10603	<b>69.-</b>

## Entlüftungen

### Art.-Nr.: E 23 Tank Be- und Entlüftung rostfrei

	DN	Höhe (mm)	Art.Nr.	CHF / Stk. 1.4301	Art.Nr.	CHF / Stk. 1.4404
	40	150	10701	354.-	10702	416.-
	60	200	10703	395.-	10704	464.-
	100	245	10705	416.-	10706	491.-
	150		10707	806.-	10708	949.-
	250		10709	1'029.-	10710	1'212.-

### Art.-Nr.: E 25 Tank Be- und Entlüftung

	DN	Farbe	Art. Nr.	CHF / Stk.
	50	grau	10711	157.-

### Art.-Nr.: E 27 Tank Be- und Entlüftung

	Zoll	Farbe	Art. Nr.	CHF / Stk.
	1 ¼"	weiss	10712	61.-

### Art.: Druckausgleichsventil (Be- und Entlüftung)

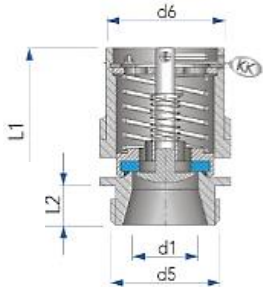
	DN	Dimension (mm)	Druck (bar)	Art.Nr.	CHF / Stk. 1.4301
	20	54 x 40	+0.2 / -0.05	10713	204.-
	20	54 x 40	+0.4 / - 0.05	10714	204.-
	20	54 x 40	+0.65 / -0.05	10715	204.-

## Schaugläser und Tankbeleuchtungen

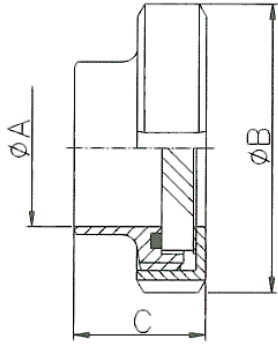
Art.: Schauglas					
	DN	Ø (mm)	Höhe (mm)	Art.Nr.	CHF / Stk. 1.4404 pol.
	25	26 / 63	37	10801	104.-
	32	32 / 70	40	10802	126.-
	40	38 / 78	41	10803	135.-
	50	50 / 92	43	10804	153.-
	65	66 / 112	48	10805	198.-
	80	81 / 127	58	10806	262.-
	100	100 / 148	67	10807	338.-
	125	125 / 178	58	10809	534.-
	150	150 / 210	63	10810	1'124.-

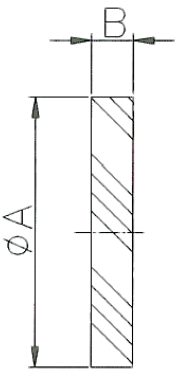
Art.: Ersatzglas zu Schauglas					
	DN	Ø (mm)	Dicke (mm)	Art.Nr.	CHF / Stk. Hartglas
	25	45	10	10811	20.-
	32	50	10	10812	22.-
	40	55	10	10813	23.-
	50	65	10	10814	26.-
	65	85	10	10815	33.-
	80	100	15	10816	52.-
	100	118	15	10817	60.-
	125	150	15	10818	97.-
	150	175	20	10819	154.-

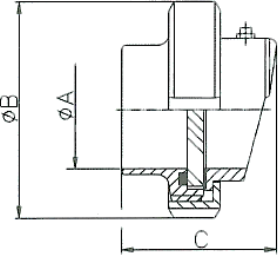
Art.: Tankbeleuchtung					
	DN	Ø (mm)	Höhe (mm)	Art.Nr.	CHF / Stk. 1.4404
	65	66 / 112	89	10820	798.-
	80	81 / 127	91	10821	1'095.-
	100	100 / 148	148	10822	1'268.-
	125	125 / 173	173	10823	1'481.-



## Getriebemotoren für Rührwerke

### Art.: Universalgetriebemotor

	Leistung (kW)	Drehzahl (1/min)	Schutzart	Art.Nr.	CHF / Stk.
	0.25	9 ... 200	IP 55	10901	<b>585.-</b>
	0.37	9 ... 200	IP 55	10902	<b>615.-</b>
	0.55	9 ... 200	IP 55	10903	<b>645.-</b>
	0.75	9 ... 200	IP 55	10904	<b>676.-</b>
	1.1	9 ... 200	IP 55	10905	<b>744.-</b>
	1.5	9 ... 200	IP 55	10906	<b>811.-</b>
	2.0	9 ... 200	IP 55	10907	<b>908.-</b>
<b>Ab 2.5 kW auf Anfrage</b>					

### Art.: Universalgetriebemotor in Glattausführung

	Leistung (kW)	Drehzahl (1/min)	Schutzart	Art.Nr.	CHF / Stk.
	0.25	9 ... 200	IP 66	10908	<b>702.-</b>
	0.37	9 ... 200	IP 66	10909	<b>737.-</b>
	0.55	9 ... 200	IP 66	10910	<b>741.-</b>
	0.75	9 ... 200	IP 66	10911	<b>811.-</b>
	1.1	9 ... 200	IP 66	10912	<b>892.-</b>
	1.5	9 ... 200	IP 66	10913	<b>973.-</b>
	2.0	9 ... 200	IP 66	10914	<b>1'089.-</b>
<b>Ab 2.5 kW auf Anfrage</b>					

### Art.: Frequenzumrichter mit Potentiometer und Schalter

	Montage	Ausgangs- frequenz (Hz)	Schutzart	Art.Nr.	CHF / Stk.
	Direktaufbau	0 ... 400	IP 55	10915	<b>1'354.-</b>
	Wandhalterung	0 ... 400	IP 55	10916	<b>1'430.-</b>
	Direktaufbau	0 ... 400	IP 66	10917	<b>1'561.-</b>
	Wandhalterung	0 ... 400	IP 66	10918	<b>1'645.-</b>

## Ersatzteile zu Getriebemotor

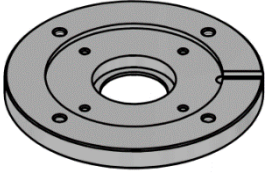
Art.: Einschweissflansch					
	Ø (mm)	Lochkreis (mm)	kW	Art.Nr.	CHF / Stk. 1.4404
	160	130	0.25 ... 0.75	11001	526.-
	200	165	1.1 ... 2.0	11002	572.-

Art.: Wellendichtung					
	Wellen-Ø (mm)	Material	FDA-Zertifikat	Art.Nr.	CHF / Stk.
	15 ... 30	NBR	Ja *	11003	65.-
	15 ... 30	EPDM	Ja *	11004	65.-
	15 ... 30	Silikon	Ja *	11005	91.-
	15 ... 30	Viton	Ja *	11006	91.-
	*FDA-Bescheinigung zzgl. CHF 25.-				

## Rührorgane

### Art.: Rührflügel gebogen

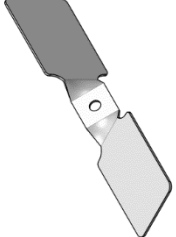
	Ø (mm)	Oberflächenbeschaffenheit	Art.Nr.	CHF / Stk. 1.4404	Art.Nr.	CHF / Stk. 1.4571
	400	geschl. / pol. Ra 0.8	11101	188.-	11102	208.-
	500	geschl. / pol. Ra 0.8	11103	218.-	11104	240.-
	600	geschl. / pol. Ra 0.8	11105	255.-	11106	279.-

### Art.: Rührflügel gekantet

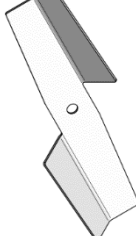
	Ø (mm)	Oberflächenbeschaffenheit	Art.Nr.	CHF / Stk. 1.4404	Art.Nr.	CHF / Stk. 1.4571
	200	geschl. / pol. Ra 0.4	11107	201.-	11108	221.-
	300	geschl. / pol. Ra 0.4	11109	212.-	11110	233.-
	400	Geschl. / pol. Ra 0.4	11111	225.-	11112	248.-

### Art.: Dissolver

	Ø (mm)	Dicke (mm)	Oberflächenbeschaffenheit	Art.Nr.	CHF / Stk. 1.4571
	150	1.5	geschl. / pol. Ra 0.8	11113	342.-
	170	2.0	geschl. / pol. Ra 0.8	11114	355.-
	200	2.0	geschl. / pol. Ra 0.8	11115	364.-
	220	2.5	geschl. / pol. Ra 0.8	11116	396.-
	250	2.5	geschl. / pol. Ra 0.8	11117	411.-

### Art.: Becherrührwerk

	Ø (mm)	Oberflächenbeschaffenheit	Art.Nr.	CHF / Stk. 1.4404	Art.Nr.	CHF / Stk. 1.4571
	300	geschl. / pol. Ra 0.8	11118	1'191.-	11119	1'370.-
	400	geschl. / pol. Ra 0.8	11120	1'488.-	11121	1'711.-
	500	geschl. / pol. Ra 0.8	11122	1'859.-	11123	2'138.-
<b>- Schonendes Mischverhalten – niedrig viskose Medien</b>						

### Art.: Becherrührwerk mit Laminarerzeuger

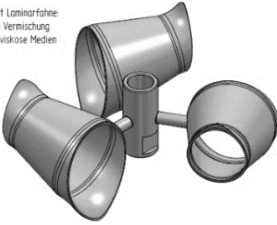
 <p>mit Laminarfließen- e Vermischung viskose Medien</p>	Ø (mm)	Oberflächen- beschaffenheit	Art.Nr.	CHF / Stk. 1.4404	Art.Nr.	CHF / Stk. 1.4571
		geschl. / pol. Ra 0.8	11201	1'605.-	11202	1'785.-
		geschl. / pol. Ra 0.8	11203	1'904.-	11204	2'127.-
		geschl. / pol. Ra 0.8	11205	2'275.-	11206	2'553.-
<b>- Schonendes und starkes Mischverhalten – niedrig viskose Medien</b>						

### Art.: Spiralbecher rund

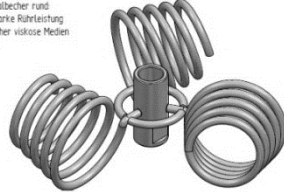
 <p>albecher rund starke Rührleistung höher viskose Medien</p>	Ø (mm)	Oberflächen- beschaffenheit	Art.Nr.	CHF / Stk. 1.4404	Art.Nr.	CHF / Stk. 1.4571
		geschl. / pol. Ra 0.8	11207	1'498.-	11208	1'722.-
		geschl. / pol. Ra 0.8	11209	1'872.-	11210	2'153.-
		geschl. / pol. Ra 0.8	11211	2'314.-	11212	2'690.-
<b>- starke Rührleistung – höher viskose Medien</b>						

### Art.: Spiralbecher scharfkantig

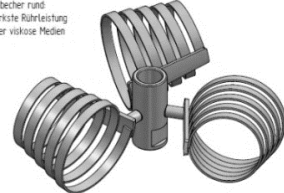
 <p>becher rund stärkste Rührleistung höher viskose Medien</p>	Ø (mm)	Oberflächen- beschaffenheit	Art.Nr.	CHF / Stk. 1.4404	Art.Nr.	CHF / Stk. 1.4571
	300	geschl. / pol. Ra 0.8	11213	1498.-	11214	1'722.-
	400	geschl. / pol. Ra 0.8	11215	1'872.-	11216	2'153.-
	500	geschl. / pol. Ra 0.8	11217	2'339.-	11218	2'691.-
<b>- stärkste Rührleistung – höher viskose Medien</b>						

## Reinigungsturbinen

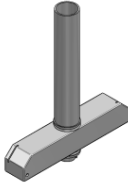
Art.: BE-RT 25					
	Pumpendruck (bar)	Flüssigkeitsmenge (l/h)	Sprüh-Ø (mm)	Art.Nr.	CHF / Stk. 1.4404
	0.5	600	1'000	11300	257.-
	1.0	1'600	2'000		
	1.8	3'200	3'000		
Mit Rohr Ø 21.3 mm					

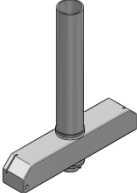
Art.: BE-RT 32					
	Pumpendruck (bar)	Flüssigkeitsmenge (l/h)	Sprüh-Ø (mm)	Art.Nr.	CHF / Stk. 1.4404
	0.75	5'100	3'000	11301	465.-
	1.0	6'000	5'000		
	2.0	7'500	7'000		
Mit Rohr Ø 28 mm					

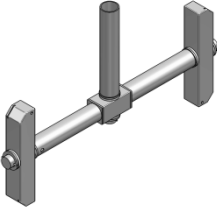
Art.: BE-RT 25/32 Doppelreinigungsturbine					
	Pumpendruck (bar)	Flüssigkeitsmenge (l/h)	Sprüh-Ø (mm)	Art.Nr.	CHF / Stk. 1.4404
	1.0	1'200	2'000	11302	679.-
	2.0	3'200	4'000		
	3.6	6'400	6'000		
Mit Rohr Ø 28 mm					

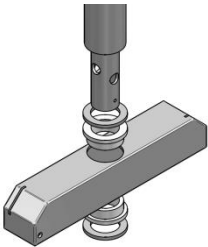
Art.: Ersatzteile BE-RT						
	Artikel	Menge / Turbine	Art. Nr.	CHF / Stk. BE-RT 25	Art.Nr.	CHF / Stk. BE-RT 32
	Rotor	1	11303	148.-	11304	295.-
	Stator	1	11305	51.-	11306	103.-
	Lager	2	11307	15.-	11308	30.-
	U-Scheibe	2	11309	1.-	11310	1.75
	Splinten	1	11311	1.-	11312	2.55

## Sprühkugeln

### Art.: Sprühkugel 360° m. Splint

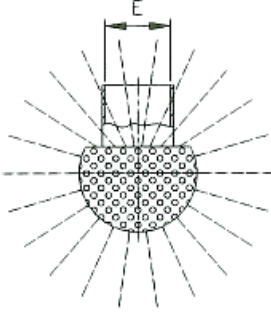
	DN	Durchsatz (m <sup>3</sup> /h)	Spritzkreis-Ø (m)	Art.Nr.	CHF / Stk. 1.4571 blank
	10	2.1	0.5 ... 1.0	11401	192.-
	15	4.2	1.5 ... 1.5	11402	203.-
	20	7.7	2.0 ... 2.5	11403	207.-
	25	11.0	2.0 ... 3.0	11404	218.-
	25	17.5	3.0 ... 4.0	11405	282.-
	32	1.5	2.5 ... 3.5	11406	286.-
	32	21.7	3.0 ... 4.0	11407	352.-
	40	11.8	2.5 ... 3.5	11408	299.-
	40	22.8	3.0 ... 4.0	11409	367.-
	50	28.6	4.0 ... 4.5	11410	455.-
	50	49.1	6.0	11411	578.-
	<b>Weitere Sprühbilder 180°/270° auf Anfrage!</b>				

## Stellfüsse / Kalottenteller

Art.: Kalottenfuss / Stellfuss					
	Grösse			Art.Nr.	CHF / Stk.
	1/2"			11501	97.-
	1"			11502	157.-
	<b>Komplett mit Feststellmutter und Muffe</b>				

Art.: Kalottenteller / Fussplatte					
	Grösse	Ø (mm)		Art.Nr.	CHF / Stk.
	1	60		11503	23.-
	2	85		11504	32.-
	3	120		11505	35.-

## Tankböden

### Art.: Tankboden flach mit Radius

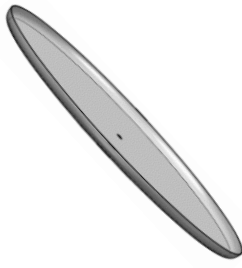
	Ø (mm)	Dicke (mm)	Oberflächenbeschaffenheit	Art.Nr.	CHF / kg 1.4301	Art.Nr.	CHF / kg 1.4404
	400 ... 3'960	1 ... 5	blank 2B	11601	18.-	11602	20.-
<b>Auch geschliffen und poliert bis Ra 0.4 erhältlich</b>							

### Art.: Tankboden konisch mit Radius

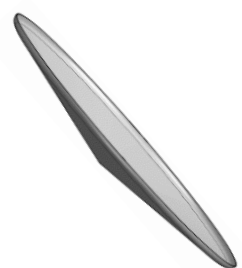
	Ø (mm)	Dicke (mm)	Oberflächenbeschaffenheit	Art.Nr.	CHF / kg 1.4301	Art.Nr.	CHF / kg 1.4404
	400 ... 3'960	1 ... 5	blank 2B	11603	29.-	11604	31.-
<b>Auch geschliffen und poliert bis Ra 0.4 erhältlich</b>							



## 2. Armaturen für die Lebensmittelindustrie

### DIN Armaturen

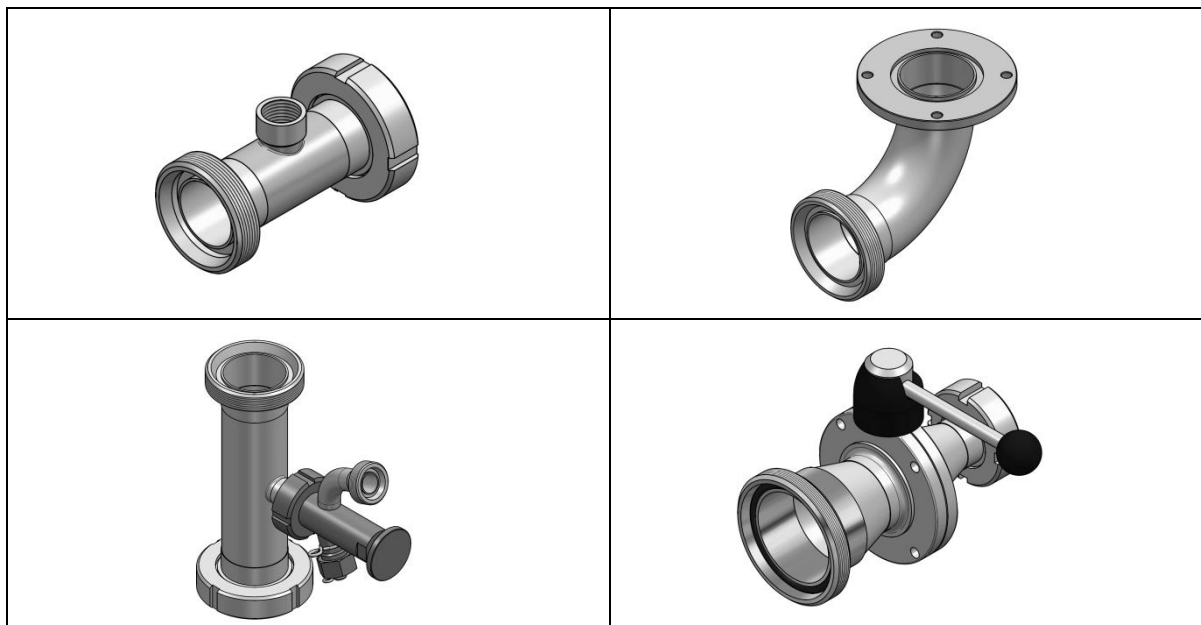

*Geben Sie uns Ihre Masse, Anschlussgrösse, Form, das gewünschte Material und die Oberflächenbeschaffenheit an. Wir produzieren Ihnen schnell und kompetent jegliche Kombination von Lebensmittelarmaturen.*

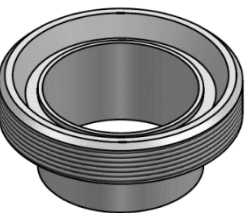
Art.: Gewindestutzen schweiss							
	DN	Aussen-Ø (mm)	Höhe (mm)	Art.Nr.	CHF / Stk. 1.4301 pol.	Art.Nr.	CHF / Stk. 1.4404 pol.
	10	13	21	21701	10.-	21702	13.-
	15	19	21	21703	12.-	21704	15.-
	20	23	24	21705	14.-	21706	19.-
	25	29	29	21707	13.-	21708	19.-
	32	35	32	21709	15.-	21710	19.-
	40	41	33	21711	15.-	21712	20.-
	50	53	35	21713	17.-	21714	22.-
	65	70	40	21715	25.-	21716	33.-
	80	85	45	21717	40.-	21718	52.-
	100	104	54	21719	59.-	21720	77.-
	125	129	46	21721	105.-	21722	137.-
150	154	50	21723	156.-	21724	203.-	

**Art.: Kegelstutzen schweiss**

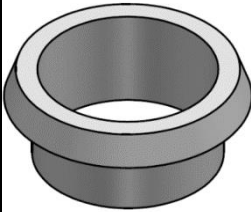
	DN	Aussen-Ø (mm)	Höhe (mm)	Art.Nr.	CHF / Stk. 1.4301 pol.	Art.Nr.	CHF / Stk. 1.4404 pol.
	10	13	17	21801	5.60	21802	7.10
	15	19	17	21803	5.95	21804	7.80
	20	23	18	21805	8.20	21806	10.70
	25	29	22	21807	8.60	21808	11.10
	32	35	25	21809	10.-	21810	13.-
	40	41	26	21811	12.-	21812	14.-
	50	53	28	21813	13.-	21814	17.-
	65	70	32	21815	18.-	21816	24.-
	80	85	37	21817	27.-	21818	35.-
	100	104	44	21819	43.-	21820	56.-
	125	129	34	21821	78.-	21822	102.-
	150	154	37	21823	148.-	21824	193.-

**Art.: Nutmutter**

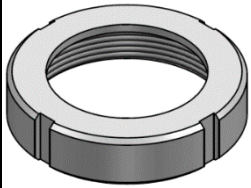
	DN	Aussen-Ø (mm)	Höhe (mm)	Art.Nr.	CHF / Stk. 1.4301 pol.	Art.Nr.	CHF / Stk. 1.4404 pol.
	10	38	18	21825	12.-	21826	17.-
	15	44	18	21827	13.-	21828	18.-
	20	54	20	21829	14.-	21830	19.-
	25	63	21	21831	15.-	21832	19.-
	32	70	21	21833	16.-	21834	21.-
	40	78	21	21835	16.-	21836	21.-
	50	92	22	21837	17.-	21838	23.-
	65	112	25	21839	26.-	21840	36.-
	80	127	29	21841	40.-	21842	54.-
	100	148	31	21843	55.-	21844	75.-
	125	178	35	21845	104.-		-
	150	210	40	21846	181.-		-

**Art.: Dichtung G DIN 11851**

	DN	Innen-Ø (mm)	Höhe (mm)	Art.Nr.	CHF / Stk. Perbunan	Art.Nr.	CHF / Stk. Silikon	
	10	12	4.5	21847	0.75	21848	1.30	
	15	18	4.5	21849	0.75	21850	1.30	
	20	23	4.5	21851	0.75	21852	1.30	
	25	30	5.0 / 8.0	21853	0.90 / 2.20	21854	1.60	
	32	36	5.0 / 8.0	21855	0.90 / 2.20	21856	1.60	
	40	42	5.0 / 8.0	21857	1.15 / 3.10	21858	1.70	
	50	54	5.0 / 8.0	21859	1.15 / 3.10	21860	1.70	
	65	71	5.0 / 8.0	21861	1.30 / 4.25	21862	2.50	
	80	85	5.0 / 8.0	21863	1.30 / 4.85	21864	3.10	
	100	104	6.5 / 8.0	21865	1.60 / 5.60	21866	6.60	
	<b>Weitere Materialien auf Anfrage!</b>	125	130	7.0 / 8.0	21867	2.50 / 10.90	21868	6.60
		150	155	7.0 / 8.0	21869	2.95 / 13.10	21870	7.80

**Art.: Kleinflansch mit Nut**

	DN	Aussen- Ø d5 (mm)	Höhe f (mm)	Lochkreis K (mm)	Art.Nr.	CHF / Stk. 1.4301	Art.Nr.	CHF / Stk. 1.4404
	15	62	24	48		-	21901	49.-
	20	72	24	58		-	21902	73.-
	25	80	24	65	21903	34.-	21904	43.-
	32	86	24	71	21905	35.-	21906	46.-
	40	92	24	77	21907	37.-	21908	48.-
	50	108	24	92	21909	39.-	21910	51.-
	65	130	24	110	21911	49.-	21912	63.-
	80	146	24	126	21913	67.-	21914	88.-
	100	166	24	146	21915	84.-	21916	109.-
	125	205	23	180	21917	181.-	21918	209.-
	150	240	23	215	21919	278.-	21920	312.-

**Art.: Kleinflansch ohne Nut**

	DN	Aussen- Ø d5 (mm)	Höhe f (mm)	Lochkreis K (mm)	Art.Nr.	CHF / Stk. 1.4301	Art.Nr.	CHF / Stk. 1.4404
	15	62	24	48		-	21921	49.-
	20	72	24	58		-	21922	73.-
	25	80	24	65	21923	33.-	21924	43.-
	32	86	24	71	21925	35.-	21926	46.-
	40	92	24	77	21927	37.-	21928	48.-
	50	108	24	92	21929	39.-	21930	51.-
	65	130	24	110	21931	49.-	21932	63.-
	80	146	24	126	21933	68.-	21934	88.-
	100	166	24	146	21935	84.-	21936	109.-
	125	205	23	180	21937	181.-	21938	209.-
	150	240	23	215	21939	278.-	21940	312.-

**Art.: Dichtung zu Kleinflanschverbindung**

	DN	Aussen- Ø d7 (mm)	Innen-Ø d12 (mm)	Dicke s (mm)	Art.Nr.	CHF / Stk. k-flex
	15	21	16	2	21941	17.45
	20	28	20	2	21942	16.15
	25	35	26	2	21943	7.95
	32	41	32	2	21944	9.65
	40	47	38	2	21945	10.-
	50	59	50	2.2	21946	11.-
	65	76	66	2.2	21947	13.25
	80	90	81	2.2	21848	17.45
	100	109	100	2.2	21949	23.65
	125	136	125	2.2	21950	29.55
	150	161	150	2.6	21951	49.70

### Art.: Schlauchkegelstutzen

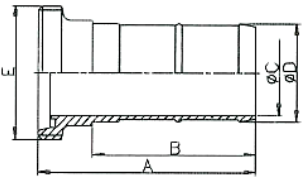
	DN	Länge (mm)	Art.Nr.	CHF / Stk. 1.4301 pol.	Art.Nr.	CHF / Stk. 1.4404 pol.
	25	76	22001	51.-	22002	69.-
32	90	22003	65.-	22004	88.-	
40	105	22005	84.-	22006	114.-	
50	120	22007	105.-	22008	124.-	
65	140	22009	135.-	22010	168.-	
<b>Weitere Ausführungen auf Anfrage!</b>	80	164	22011	267.-	22012	363.-
	100	180	22013	333.-	22014	452.-

### Art.: Rohrbogen 90° schweiss

	DN	Aussen-Ø (mm)	Stärke (mm)	Radius (mm)	Art.Nr.	CHF / Stk. 1.4301 pol.	Art.Nr.	CHF / Stk. 1.4404 pol.
	10	12	1.5	26	22015	11.-	22016	12.-
15	18	1.5	35	22017	12.-	22018	13.-	
20	22	1.5	40	22019	13.-	22020	14.-	
25	28	1.5	50	22021	10.-	22022	11.-	
32	34	1.5	55	22023	12.-	22024	13.-	
40	40	1.5	60	22025	14.-	22026	15.-	
50	52	1.5	70	22027	16.-	22028	18.-	
65	70	2.0	80	22029	28.-	22030	31.-	
80	85	2.0	90	22031	45.-	22032	50.-	
100	104	2.0	100	22033	61.-	22034	67.-	
125	129	2.0	187.5	22035	130.-	22036	141.-	
<b>Weitere Ausführungen auf Anfrage!</b>	150	154	2.0	225	22037	185.-	22038	202.-
	200	204	2.0	300	22039	385.-	22040	410.-

### Art.: T-Stück schweiss

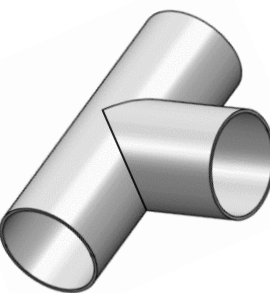
	DN	Aussen-Ø (mm)	Dicke (mm)	Länge z. Zentrum (mm)	Art.Nr.	CHF / Stk. 1.4301 pol.	Art.Nr.	CHF / Stk. 1.4404 pol.
	10	13	1.5	26	22041	26.-	22043	35.-
15	19	1.5	35	22043	25.-	22044	34.-	
20	22	1.5	40	22045	23.-	22046	31.-	
25	28	1.5	50	22047	18.-	22048	25.-	
32	34	1.5	55	22049	20.-	22050	27.-	
40	40	1.5	60	22051	23.-	22052	32.-	
50	52	1.5	70	22053	28.-	22054	38.-	
65	70	2.0	80	22055	42.-	22056	57.-	
80	85	2.0	90	22057	57.-	22058	77.-	
100	104	2.0	100	22059	80.-	22060	108.-	
<b>Weitere Ausführungen auf Anfrage!</b>	125	129	2.0	187.5	22061	209.-	22062	281.-
	150	154	2.0	225	22063	277.-	22064	360.-

**Art.: Reduzierstück konzentrisch schweiss**

	DN	Ø klein (mm)	Ø gross (mm)	Stärke (mm)	Länge (mm)	Art.Nr.	CHF / Stk. 1.4301 pol.	Art.Nr.	CHF / Stk. 1.4404 pol.
	15/10	10	16	1.5	11	22101	12.-	22102	13.-
	20/10	10	20	1.5	18	22103	13.-	22104	14.-
	20/15	16	20	1.5	7	22105	13.-	22106	14.-
	25/10	10	26	1.5	30	22107	20.-	22108	24.-
	25/15	16	26	1.5	18	22109	15.-	22110	17.-
	25/20	20	26	1.5	11	22111	13.-	22112	14.-
	32/15	16	32	1.5	30	22113	19.-	22114	21.-
	32/20	20	32	1.5	22	22115	12.-	22116	13.-
	32/25	26	32	1.5	11	22117	10.-	22118	11.-
	40/15	16	38	1.5	41	22119	35.-	22120	39.-
	40/20	20	38	1.5	33	22121	28.-	22122	31.-
	40/25	26	38	1.5	22	22123	15.-	22124	16.-
	40/32	32	38	1.5	11	22125	13.-	22126	14.-
	50/20	20	50	1.5	55.5	22127	41.-	22128	43.-
	50/25	26	50	1.5	44	22129	27.-	22130	34.-
	50/32	32	50	1.5	33	22131	18.-	22132	19.-
	50/40	38	50	1.5	22	22133	14.-	22134	16.-
	65/25	26	66	2.0	74.5	22135	43.-	22136	47.-
	65/32	32	66	2.0	63.5	22137	39.-	22138	43.-
	65/40	38	66	2.0	51	22139	22.-	22140	24.-
	65/50	50	66	2.0	29	22141	17.-	22142	19.-
	80/32	32	81	2.0	91.5	22143	57.-	22144	63.-
	80/40	38	81	2.0	80.2	22145	52.-	22146	57.-
	80/50	50	81	2.0	56	22147	33.-	22148	35.-
	80/65	66	81	2.0	27	22149	25.-	22150	27.-
	100/50	50	100	2.0	93	22151	61.-	22152	67.-
	100/65	66	100	2.0	61	22153	41.-	22154	42.-
	100/80	81	100	2.0	34	22155	29.-	22156	32.-
	125/50	50	125	2.0	135	22157	126.-	22158	139.-
	125/65	66	125	2.0	110	22159	104.-	22160	113.-
	125/80	81	125	2.0	79	22161	58.-	22162	64.-
	125/100	100	125	2.0	45	22163	46.-	22164	50.-
	150/50	50	150	2.0	184	22165	202.-	22166	222.-
	150/65	66	150	2.0	151	22167	170.-	22168	190.-
	150/80	81	150	2.0	128.7	22169	176.-	22170	146.-
	150/100	100	150	2.0	90	22171	69.-	22172	75.-
<b>Weitere Ausführungen auf Anfrage!</b>	150/125	125	150	2.0	45	22173	45.-	22174	55.-
	200/125	125	200	2.0	140	22175	218.-	22176	238.-

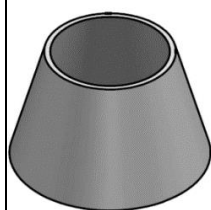

## Lebensmittelrohre

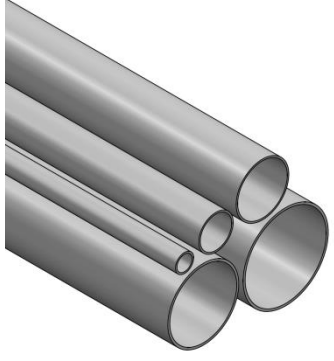
Art.: Lebensmittelrohr geschliffen					
	DN	Aussen-Ø (mm)	Dicke (mm)	CHF / m 1.4301 pol.	CHF / m 1.4404 pol.
	10	12	1.5	<b>Auf Anfrage</b>	
	15	18	1.5		
	20	22	1.5		
	25	28	1.5		
	32	34	1.5		
	40	40	1.5		
	50	52	1.5		
	65	70	2.0		
	80	85	2.0		
	100	104	2.0		
	125	129	2.0		
	150	154	2.0		

## Ventile für Lebensmittel (M&S)

### Art.: Scheibenventil Handbetätigung schweiss

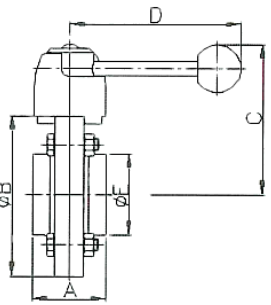
	DN	Aussen-Ø (mm)	Breite (mm)	Art.Nr.	CHF / Stk. 1.4301	Art.Nr.	CHF / Stk. 1.4404
		15	20	40	22301	324.-	22302
	20	24	40	22303	330.-	22304	421.-
	25	30	40	22305	209.-	22306	272.-
	32	36	42	22307	224.-	22308	290.-
	40	42	50	22309	221.-	22310	288.-
	50	54	50	22311	237.-	22312	308.-
	65	70	50	22313	289.-	22314	375.-
	80	85	60	22315	392.-	22316	517.-
<b>Weitere Ausführungen (z.B.: G-S/G-G/K-S...) auf Anfrage!</b>	100	104	64	22317	492.-	22318	646.-
	125	129	86	22319	1'095.-	22320	1'439.-
	150	154	90	22321	1'605.-	22322	2'101.-

### Art.: Scheibenventil Antrieb PAMS schweiss

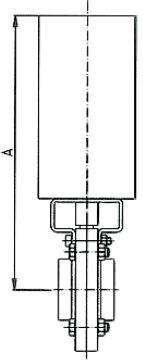
	DN	Aussen-Ø (mm)	Länge (mm)	Art.Nr.	CHF / Stk. 1.4301	Art.Nr.	CHF / Stk. 1.4404
		15	20	220	22323	874.-	22324
	20	24	220	22325	879.-	22326	971.-
	25	30	220	22327	759.-	22328	821.-
	32	36	223	22329	773.-	22330	840.-
	40	42	225	22331	771.-	22332	838.-
	50	54	232	22333	786.-	22334	858.-
	65	70	240	22335	838.-	22336	924.-
	80	85	248	22337	940.-	22338	1'065.-
<b>Weitere Ausführungen (z.B.: G-S/G-G/K-S...) auf Anfrage!</b>	100	104	258	22339	1'040.-	22340	1'194.-
	125	129	344	22341	2'518.-	22342	2'861.-
	150	154	358	22343	3'024.-	22344	3'524.-

### Art.: Steuer- und Rückmeldekopf TOP

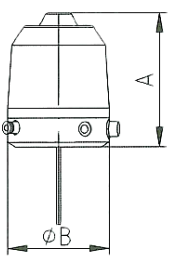
	DN	Höhe (mm)	Ø (mm)	Art.Nr.	CHF / Stk. 2 Ni	Art.Nr.	CHF / Stk. 2 Ni MV
		15 ... 100	138	104	22345	589.-	22346
Ni: Näherungsinitiator / MV: Magnetventil							

## Ersatzteile zu Scheibenventil (M&S)

### Art.: Handbetätigung

	DN	Länge (mm)	Aussparung (mm)	Art.Nr.	CHF / Stk. 1.4301
	15 ... 50	122	9.5	22401	44.-
	65 ... 100	150	9.5	22402	45.-
	125 ... 150	216	14	22403	87.-

### Art.: Scheibenventil Klappe

	DN	Klappen-Ø (mm)	Schaft (mm)	Art.Nr.	CHF / Stk. 1.4301	Art.Nr.	CHF / Stk. 1.4404
	25	26	9.5	22404	81.-	22405	104.-
	32	32	9.5	22406	83.-	22407	108.-
	40	38	9.5	22408	84.-	22409	110.-
	50	50	9.5	22410	103.-	22411	133.-
	65	66	9.5	22412	124.-	22413	162.-
	80	81	9.5	22414	149.-	22415	193.-
	100	100	9.5	22416	225.-	22417	292.-
	125	125	14	22418	426.-	22419	502.-
	150	150	14	22420	675.-	22421	783.-

### Art.: Scheibenventil –Dichtung „neue Bauform“

	DN	Aussen-Ø (mm)	Breite (mm)	Art.Nr.	CHF / Stk. VMQ	Art.Nr.	CHF / Stk. HNBR
	25	41	20	22422	16.-	22423	81.-
	32	47	20	22424	16.50	22425	64.-
	40	54	21	22426	17.-	22427	75.-
	50	67	21	22428	17.50	22429	96.-
	65	84	22	22430	23.-	22431	104.-
	80	99	24	22432	39.-	22433	132.-
	100	118	26	22434	59.-	22435	186.-
	125	148	30	22436	89.-	22437	236.-
	150	173	32	22438	110.-	22439	422.-



**Art.: Scheibenventil –Dichtung „alte Bauform“**

	DN	Aussen- Ø (mm)	Breite (mm)	Art.Nr.	CHF / Stk. VMQ	Art.Nr.	CHF / Stk. HNBR
	25	40	20	22501	<b>15.50</b>	22502	<b>79.-</b>
	32	48	20	22503	<b>16.-</b>	22504	<b>63.-</b>
	40	54	21	22505	<b>17.-</b>	22506	<b>83.-</b>
	50	66	21	22507	<b>17.50</b>	22508	<b>102.-</b>
	65	84	22	22509	<b>22.50</b>	22510	<b>121.-</b>
	80	100	24	22511	<b>34.-</b>	22512	<b>139.-</b>
	100	115	26	22513	<b>58.-</b>	22514	<b>199.-</b>
	125	151	30	22515	<b>88.-</b>	22516	<b>295.-</b>
	150	175	32	22517	<b>108.-</b>	22518	<b>517.-</b>

## Ventile für Lebensmittel (Kieselmann)

### Art.: Scheibenventil handbetätigt schweiss

	DN	Aussen-Ø (mm)	Breite (mm)	Art.Nr.	CHF / Stk. 1.4301	Art.Nr.	CHF / Stk. 1.4404
	15	19	48	22601	a.A.	22602	a.A.
	20	23	48	22603	a.A.	22604	a.A.
	25	29	54	22605	175.-	22606	210.-
	32	35	54	22607	179.-	22608	215.-
	40	41	54	22609	181.-	22610	217.-
	50	53	58	22611	192.-	22612	231.-
	65	70	60	22613	239.-	22614	287.-
	80	85	72	22615	335.-	22616	402.-
<b>Weitere Ausführungen (z.B.: G-S/G-G/K-S...) auf Anfrage!</b>	100	104	68	22617	423.-	22618	508.-
	125	129	86	22619	1'062.-	22620	1'274.-
	150	154	104	22621	1'446.-	22622	1'880.-

### Art.: Scheibenventil pneum. betätigt schweiss

	DN	Aussen-Ø (mm)	Länge (mm)	Art.Nr.	CHF / Stk. 1.4301	Art.Nr.	CHF / Stk. 1.4404
	15	19	232	22623	a.A.	22624	a.A.
	20	23	237	22625	a.A.	22626	a.A.
	25	29	285	22627	545.-	22628	580.-
	32	35	288	22629	550.-	22630	586.-
	40	41	291	22631	552.-	22632	588.-
	50	53	300	22633	563.-	22634	601.-
	65	70	311	22635	610.-	22636	658.-
	80	85	319	22637	705.-	22638	772.-
<b>Weitere Ausführungen (z.B.: G-S/G-G/K-S...) auf Anfrage!</b>	100	104	329	22639	794.-	22640	878.-
	125	129	388	22641	2'104.-	22642	2'525.-
	150	154	407	22643	2'488.-	22644	3'235.-

### Art.: Elektrischer Steuerkopf KI-TOP

	DN	Höhe (mm)	Ø (mm)	Art.Nr.	CHF / Stk. 1 MV/ES	Art.Nr.	CHF / Stk. 2 MV/ES
	15 ... 100	129	105	22645	694.-	22646	877.-
	<i>Kunststoffhaube transparent</i>						
15 ... 100	129	105	22647	893.-	22648	1'076.-	
<i>Edelstahlhaube m. Rundumleuchte</i>							
Weitere Ausführungen auf Anfrage!							

## Ersatzteile zu Scheibenventil (Kieselmann)

### Art.: Handhebel

	DN	Länge (mm)	Aussparung (mm)	Art.Nr.	CHF / Stk.
	15 ... 20	100	10	22701	32.-
	25 ... 100	165	10	22702	32.-

### Art.: Handhebel Edelstahl

	DN	Länge (mm)	Aussparung (mm)	Art.Nr.	CHF / Stk. 1.4301
	15 ... 50	101	10	22703	58.-
	25 ... 50	146	10	22704	58.-
	65 ... 100	180	10	22705	58.-
	125 ... 150	185	14	22706	147.-

### Art.: Scheibenventil –Dichtung

	DN	Aussen-Ø (mm)	Breite (mm)	Art.Nr.	CHF / Stk. VMQ	Art.Nr.	CHF / Stk. HNBR
	25	43	26	22707	17.-	22708	42.-
	32	50	26	22709	19.-	22710	44.-
	40	57	27	22711	21.-	22712	47.-
	50	71	29	22713	24.-	22714	48.-
	65	87	29	22715	28.-	22716	63.-
	80	104	32	22717	32.-	22718	85.-
	100	124	35	22719	37.-	22720	106.-
	125	150	39	22721	81.-	22722	141.-
	150	177	41	22723	94.-	22724	181.-

## Ventile allgemein

### Art.: Probeentnahmeventil komplett

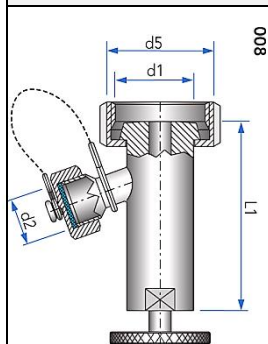

DN	Länge (mm)	Anschluss (G)	Art.Nr.	CHF / Stk. 1.4301	Art.Nr.	CHF / Stk. 1.4404
6	82	$\frac{3}{8}$	22801	216.-	22802	269.-
10	85	$\frac{1}{2}$	22803	222.-	22804	277.-
15	85	$\frac{1}{2}$	22805	229.-	22806	286.-
Ersatzteilsatz			22807			19.-
<b>Optional mit Spülstutzen erhältlich → zzgl. CHF 53.25.-/Stk</b>						

### Art.: Sicherheitsventil K/M-G nach DGRL

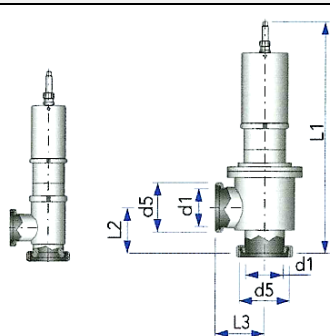

DN	Länge L1 (mm)	Länge L2 (mm)	Länge L3 (mm)	Art.Nr.	CHF / Stk. 1.4404
25	360	67	77	22808	922.-
40	370	63	82	22809	1'157.-
50	380	70	93	22810	1'536.-
65	520	78	105	22811	1'932.-
80	550	90	115	22812	2'310.-
100	660	120	130	22813	4'077.-
<b>Bei Bestellung bitte Einstelldruck angeben</b>					

### Art.: Tellerrückschlagventil K/M-G

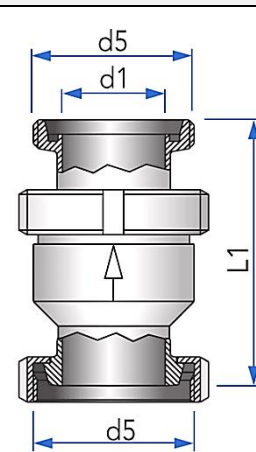

DN	Länge (mm)	Ansprechdruck (bar)	Art.Nr.	CHF / Stk. 1.4301	Art.Nr.	CHF / Stk. 1.4404
10	93	0.5		-	22814	249.-
15	98	0.4		-	22815	257.-
20	107	0.2		-	22816	268.-
25	114	0.11	22817	243.-	22818	292.-
32	125	0.09	22819	272.-	22820	327.-
40	136	0.14	22821	296.-	22822	356.-
50	149	0.15	22823	360.-	22824	432.-
65	173	0.16	22825	535.-	22826	642.-
80	199	0.15	22827	771.-	22828	920.-
100	240	0.07	22829	1'201.-	22830	1'441.-

## Eckrohrsieb

Art.: Eckrohrsieb						
	DN	Länge (mm)	Länge L1 (mm)	Länge L2 (mm)	Art.Nr.	CHF / Stk. 1.4301/1.4404
	25	554	406	82	22901 / 22902	Sämtliche Preise auf Anfrage
	32	549	401	77	22903 / 22904	
	40	534	386	85	22905 / 22906	
	50	585	413	115	22907 / 22908	
	65	558	386	113	22909 / 22910	
	80	767	563	150	22911 / 22912	
	100	721	517	167	22913 / 22914	
	125	923	650	165	22915 / 22916	
	150	923	650	165	22917 / 22918	
Spaltrohr-Standardweite 0.5 mm, andere auf Anfrage Optional mit Begleitheizung erhältlich						

## Schmutzfänger

Art.: Schmutzfänger						
	DN	Länge (mm)	Länge L1 (mm)	Ø D1 (mm)	Art.Nr.	CHF / Stk. 1.4301/1.4404
	25	147	123	26	22919 / 22920	Sämtliche Preise auf Anfrage
	40	172.5	153	38	22921 / 22922	
	50	187	156	50	22923 / 22924	
	65	215.5	179	65	22925 / 22926	
	80	240.5	197	80	22927 / 22928	
	100	269.5	235	100	22929 / 22930	
	Spaltrohr-Standardweite 1 mm, andere auf Anfrage					

### 3. Armaturen für die Wasser- und Abwasserindustrie

Art.: Bogen 90° 3D						
	D x S (mm)	R (mm)	Art.Nr.	Art.Nr.	CHF / Stk. 1.4301	CHF / Stk. 1.4404
	13.5 x 1.6	20		33001	-	10.-
	17.2 x 1.6	28	33002	33003	6.-	7.-
	21.3 x 1.6	27.5	33004	33005	6.-	6.-
	26.9 x 1.6	28.5	33006	33007	6.10	7.50
	33.7 x 2	38	33008	33009	6.50	7.60
	42.4 x 1.6	47.5	33010	33011	8.40	9.70
	48.3 x 1.6	57	33012	33013	9.20	10.70
	60.3 x 2	76	33014	33015	12.30	14.20
	76.1 x 2	95	33016	33017	20.30	23.10
	88.9 x 2	114.5	33018	33019	23.10	27.80
	114.3 x 2	152	33020	33021	31.10	40.60
	139.7 x 2	190	33022	33023	52.80	67.60
	168.3 x 2.6	229	33024	33025	103.-	130.-
	219.1 x 2.6	305	33026	33027	168.-	206.-
	273 x 2.6	381	33028	33029	383.-	473.-
	323.9 x 3	457	33030	33031	571.-	730.-
	356 x 3	525	33032	33033	703.-	909.-
	406 x 3	610	33034	33035	908.-	1'208.-
	456 x 3	680	33036	33037	1'418.-	1'854.-
Weitere Ausführungen auf Anfrage!	506 x 3	750	33038	33039	1'684.-	2'191.-
	606 x 3	900	33040	33041	1'615.-	2'974.-
	711.2 x 4	1'067			Auf Anfrage	

**Art.: T-Stück**

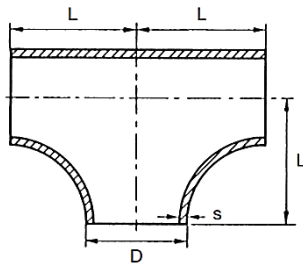

	D x S (mm)	Länge L (mm)		Art.Nr.	CHF / Stk. 1.4404
	13.5 x 1.6	18		33101	25.70
	17.2 x 1.6	20		33102	25.70
	21.3 x 1.6	25		33103	28.40
	26.9 x 1.6	29		33104	29.80
	33.7 x 2	38		33105	33.80
	33.7 x 2.6	38		33106	40.60
	42.4 x 1.6	48		33107	40.60
	42.4 x 2.6	48		33108	47.40
	48.3 x 2	57		33109	51.50
	48.3 x 2.6	57		33110	59.50
	60.3 x 2	64		33111	59.50
	76.1 x 2.3	76		33112	87.90
	88.9 x 2.3	86		33113	93.30
	114.3 x 2.6	105		33134	153.-
	139.7 x 2.6	124		33135	226.-
	168.3 x 2.6	143		33136	291.-
<b>Weitere Ausführungen auf Anfrage!</b>	219.1 x 3	178		33137	502.-
	273 x 3	216		33138	741.-
	323.9 x 3	254		33139	1'014.-

**Art.: Leitungsrohre**

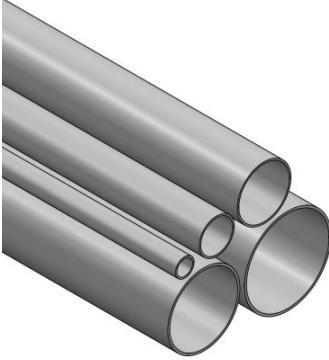
	D x S (mm)	Art.Nr.	CHF / m	CHF / m	CHF / m
			1.4301	1.4404	1.4571
	13.5 x 1.6	33201	<b>Auf Anfrage!</b>		
	17.2 x 1.6	33202			
	21.3 x 1.6	33203			
	26.9 x 1.6	33204			
	33.7 x 2	33205			
	42.4 x 1.6	33206			
	48.3 x 1.6	33207			
	60.3 x 2	33208			
	76.1 x 2	33209			
	88.9 x 2	33210			
	114.3 x 2	33211			
	139.7 x 2	33212			
	168.3 x 2.6	33213			
	219.1 x 2.6	33214			
	273 x 2.6	33215			
	323.9 x 3	33216			
	356 x 3	33217			
	<b>Weitere Wandstärken bis 3.2 mm auf Anfrage</b>	406 x 3			
456 x 3		33219			
506 x 3		33220			
606 x 3		33221			

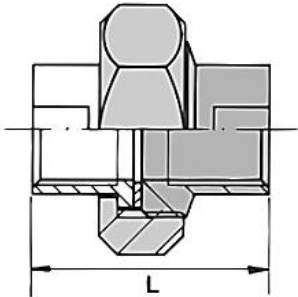

**Art.: Kupplung flachdichtend**

 	Einlegeteil (G)	Überwurfmutter (G)	Einschraubteil (G)	Länge (mm)	Art.Nr.	CHF / Stk. 1.4404
	1/8	1/2	1/8	35	33301	25.30
1/4	3/4	1/4	35	33302	28.-	
1/4	3/4	1/8	35	33303	29.10	
1/8	3/4	1/4	35	33304	27.90	
1/8	3/4	3/8	35	33305	29.60	
1/4	3/4	3/8	35	33306	29.80	
3/8	1	3/8	40	33307	33.30	
1/2	1	1/2	44	33308	37.40	
1/2	1	3/8	42	33309	33.30	
3/8	1	1/2	42	33310	37.40	
3/4	1 1/4	3/4	52	33311	54.10	
3/4	1 1/4	1/2	46	33312	53.-	
1/2	1 1/4	1/2	45	33313	52.10	
1/2	1 1/4	3/4	50	33314	53.10	
1	1 1/2	1	57	33315	54.10	
1	1 1/2	3/4	54	33316	57.10	
3/4	1 1/2	3/4	52	33317	56.40	
3/4	1 1/2	1	55	33318	53.40	
1 1/4	2	1 1/4	62	33319	79.-	
1 1/4	2	1	59	33320	82.10	
1	2	1	57	33321	81.40	
1	2	1 1/4	60	33322	78.40	
1 1/2	2 1/2	1 1/2	67	33323	109.-	
2	3	2	75	33324	179.-	
2 1/2	4	2 1/2	80	33325	296.-	
3	4	3	80	33326	305.-	
<b>Weitere Ausführungen: Schweissenden, Aussengewinde, Schlauchstutzen und Pressenden frei kombinierbar</b>	1 1/4	2	1	59	33320	82.10
	1	2	1	57	33321	81.40
	1	2	1 1/4	60	33322	78.40
	1 1/2	2 1/2	1 1/2	67	33323	109.-
	2	3	2	75	33324	179.-
	2 1/2	4	2 1/2	80	33325	296.-
	3	4	3	80	33326	305.-

**Art.: Muffe**

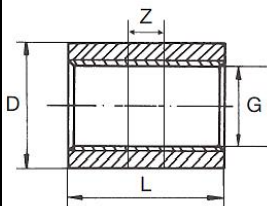

G Zoll	Länge (mm)	Ø (mm)	Art.Nr.	CHF / Stk. 1.4301	Art.Nr.	CHF / Stk. 1.4404
1/8	17	14		-	33401	3.-
1/4	25	18.5	33402	3.40	33403	3.70
3/8	26	21.3	33404	3.80	33405	4.20
1/2	34	26.5	33406	4.30	33407	4.70
3/4	36	32.5	33408	5.50	33409	6.-
1	43	39.5	33410	8.-	33411	8.80
1 1/4	48	48.3	33412	10.80	33413	12.-
1 1/2	48	54.5	33414	14.50	33415	16.-
2	56	66.3	33416	21.60	33417	24.10
2 1/2	65	82		-	33418	44.20
3	71	95		-	33419	51.70
4	79	122		-	33420	97.40
5	92	150		-	33421	288.-
6	92	180		-	33422	346.-

**Art.: Halbmuffe**

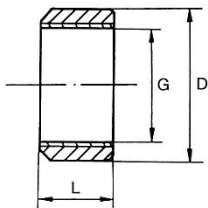

G Zoll	Länge (mm)	Ø (mm)	Art.Nr.	CHF / Stk. 1.4301	Art.Nr.	CHF / Stk. 1.4404
1/8	10	14		-	33423	2.70
1/4	11	18.5	33424	2.50	33425	3.-
3/8	12	21.3	33426	2.70	33427	3.10
1/2	15	26.5	33428	2.90	33429	3.10
3/4	17	32.5	33430	3.40	33431	3.90
1	19.5	39.5	33432	5.50	33433	6.50
1 1/4	22	48.3	33434	7.70	33435	8.80
1 1/2	22	54.5	33436	9.30	33437	10.70
2	26	66.3	33438	14.-	33439	16.10
2 1/2	30.5	82		-	33440	29.50
3	34	95		-	33441	42.90
4	39	122		-	33442	90.70

**Art.: Anschweissnippel**

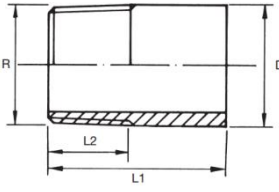
 	R Zoll	Länge (mm)	Ø (mm)	Länge L2 (mm)	Art.Nr.	CHF / Stk. 1.4404
	$\frac{1}{8}$	30	10.2	6	33501	<b>3.50</b>
$\frac{1}{4}$	30	13.5	10	33502	<b>3.50</b>	
$\frac{3}{8}$	30	17.2	10	33503	<b>3.60</b>	
$\frac{1}{2}$	35	21.3	13	33504	<b>3.60</b>	
$\frac{3}{4}$	40	26.9	15	33505	<b>4.30</b>	
1	40	33.7	17	33506	<b>5.50</b>	
1 $\frac{1}{4}$	50	42.4	19	33507	<b>7.80</b>	
1 $\frac{1}{2}$	50	48.3	19	33508	<b>9.10</b>	
2	55	60.3	24	33509	<b>13.30</b>	
2 $\frac{1}{2}$	60	76.1	27	33510	<b>21.30</b>	
<b>Weitere Längen oder Nippelenden auf Anfrage</b>	3	65	88.9	30	33511	<b>29.50</b>
	4	80	114.3	36	33512	<b>55.20</b>
	5	80	139.7	40	33513	<b>204.-</b>
	6	100	168.3	40	33514	<b>339.-</b>

### Art.: Glatte Flansche PN10

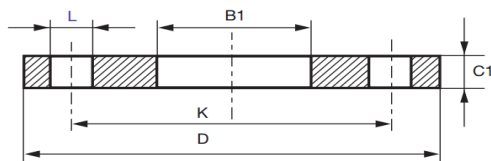

DN	Passend zu Rohr AD (mm)	D (mm)	C1 (mm)	K (mm)	Art.Nr.	CHF / Stk. 1.4301	Art.Nr.	CHF / Stk. 1.4404
200	203 ... 206	340	24	295	33601	137.-	33602	187.-
	219.1	340	24	295	33603	137.-	33604	187.-
250	253 ... 256	395	26	350	33605	227.-	33606	299.-
	273	395	26	350	33607	227.-	33608	299.-
300	303 ... 306	445	26	400	33609	290.-	33610	372.-
	323.9	445	26	400	33611	290.-	33612	372.-
350	353 ... 356	505	30	460	33613	381.-	33614	495.-
400	404 ... 406	565	32	515	33615	509.-	33616	660.-
450	456	615	36	565	33617	743.-	33618	958.-
500	506 ... 508	670	38	620	33619	821.-	33620	1'067.-
600	606 ... 608	780	42	725	33621	1'036.-	33622	1'320.-
700	711	895	50	840		-	33623	1'876.-

### Art.: Glatte Flansche PN16

DN	Passend zu Rohr AD (mm)	D (mm)	C1 (mm)	K (mm)	Art.Nr.	CHF / Stk. 1.4301	Art.Nr.	CHF / Stk. 1.4404
50	53 ... 54	165	20	125	33624	37.80	33625	50.10
	60.3	165	20	125	33626	35.20	33627	46.-
65	69 ... 70	185	18	145	33628	47.40	33629	58.10
	76.1	185	18	145	33630	44.60	33631	56.80
80	83 ... 84	200	20	160	33632	56.80	33633	69.-
	88.9	200	20	160	33634	55.40	33635	66.30
100	103 ... 106	220	22	180	33636	64.90	33637	78.50
	114.3	220	22	180	33638	64.90	33639	78.50
125	128 ... 131	250	22	210	33640	82.50	33641	112.-
	139.7	250	22	210	33642	82.50	33643	112.-
150	153 ... 156	285	24	240	33644	96.-	33645	133.-
	168.3	285	24	240	33646	96.-	33647	133.-
200	203 ... 206	340	26	295	33648	145.-	33649	196.-
	219.1	340	26	295	33650	145.-	33651	196.-
250	253 ... 256	405	29	355	33652	242.-	33653	335.-
	273	405	29	355	33654	242.-	33655	335.-
300	303 ... 306	460	32	410	33656	316.-	33657	425.-
	323.9	460	32	410	33658	316.-	33659	425.-
350	353 ... 356	520	35	470	33660	415.-	33661	556.-
400	404 ... 406	580	38	525	33662	548.-	33663	736.-
500	506 ... 508	715	46	650	33664	868.-	33665	1'162.-

**Art.: Glatte Flansche PN40**

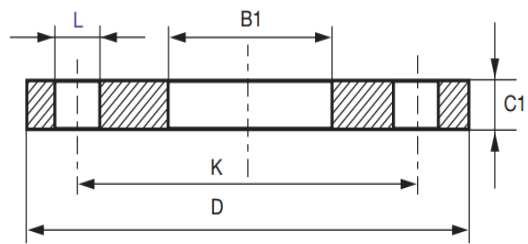

DN	Passend zu Rohr AD (mm)	D (mm)	C1 (mm)	K (mm)	Art.Nr.	CHF / Stk. 1.4301	Art.Nr.	CHF / Stk. 1.4404
10	15	90	14	60		-	33701	21.60
	17.2	90	14	60		-	33702	21.60
15	20	95	14	65		-	33703	21.60
	21.3	95	14	65	33704	18.90	33705	27.40
20	25	105	16	75	33706	21.60	33707	24.40
	26.9	105	16	75	33708	18.90	33709	23.-
25	30	115	16	85	33710	24.40	33711	27.-
	33.7	115	16	85	33712	21.60	33713	24.40
32	38	140	18	100	33714	31.10	33715	39.20
	42.4	140	18	100	33716	28.40	33717	36.50
40	43 ... 44.5	150	18	110	33718	35.20	33719	44.70
	48.3	150	18	110	33720	32.40	33721	40.60
50	53 ... 54	165	20	125	33722	52.80	33723	62.20
	60.3	165	20	125	33724	47.40	33725	56.90
65	69 ... 70	185	22	145	33726	73.10	33727	86.60
	76.1	185	22	145	33728	64.90	33729	75.80
80	83 ... 84	200	24	160	33730	97.40	33731	111.-
	88.9	200	24	160	33732	86.60	33733	98.70
100	103 ... 106	235	26	190	33734	134.-	33735	153.-
	114.3	235	26	190	33736	122.-	33737	142.-
125	139.7	270	28	220	33738	161.-	33739	200.-
150	168.3	300	30	250	33740	191.-	33741	257.-
200	219.1	375	36	320	33742	242.-	33743	330.-
250	273	450	42	385	33744	369.-	33745	525.-
300	323.9	515	52	450	33746	663.-	33747	986.-

Weitere Ausführungen wie zum Beispiel: Losflansche, Blindflansche, 2/3 Flansche etc.  
auf Anfrage

Passende Schrauben und Dichtungen auf Anfrage erhältlich

## Kugelhähne

### Art.: Kugelhahn 2-teilig, voller Durchlass



G Zoll	Länge (mm)	Ø (mm)	Höhe (mm)	Art.Nr.	CHF / Stk. 1.4404
¼	60	11.5	50	33801	<b>29.80</b>
⅜	60	12.5	50	33802	<b>29.80</b>
½	75	15	58.8	33803	<b>32.50</b>
¾	80	20	62.5	33804	<b>41.90</b>
1	90	25	69.3	33805	<b>59.50</b>
1 ¼	110	32	76	33806	<b>78.50</b>
1 ½	120	38	86.9	33807	<b>104.-</b>
2	140	50	95	33808	<b>158.-</b>
2 ½	165	65	132	33809	<b>348.-</b>
3	190	80	141	33810	<b>497.-</b>

**Mit Flügelgriff und Spindelverlängerung erhältlich**  
**Mit Aussengewinde und Schweissenden erhältlich**

## Ausbaustücke

<b>Art.: Ausbaustücke</b>					
	DN	Ø DIN (mm)	Ø ISO (mm)	Art.Nr.	CHF / Stk. 1.4404
	100	104	114.3	33901	<b>1'362.-</b>
	150	154	168.1	33902	<b>1'489.-</b>
	200	204	219.1	33903	<b>1'843.-</b>
	250	254	273	33904	<b>2'465.-</b>
	300	304	323.9	33905	<b>2'914.-</b>
	350	354	354	33906	<b>3'539.-</b>
	400	406	406	33907	<b>4'933.-</b>
	500	506	506	33908	<b>6'327.-</b>
<b>Befestigungsmaterial und Dichtung inkl.</b>					

## Expansionsgefässe

### Art.: BExpa 0.16 bis 50 Liter



- Druckgeräterichtlinie 97/23/CE
- Betriebstemperatur von -10 bis +100 °C
- Material Gefäss aus Edelstahl
- Material Membrane aus Butyl oder EPDM
- Finish poliert / geschliffen

Typ	Ø (mm)	Höhe (mm)	Anschluss (Zoll)	Max. Druck (bar)	Vordruck (bar)	Art.Nr.	CHF / Stk. 1.4404
BExpa 0.16	80	100	½	16	4	34001	48.80
BExpa 0.5	95	170	½	10	3.5	34002	72.60
BExpa 1	110	210	½	10	3.5	34003	92.30
BExpa 2	130	230	½	10	3.5	34004	119.-
BExpa 8	200	340	¾	10	2	34005	224.-
BExpa 12	270	290	¾ ... 1	10	2	34006	230.-
BExpa 18	270	390	¾ ... 1	10	2	34007	250.-
BExpa 24	270	520	¾ ... 1	8	2	34008	266.-
BExpa 50	365	560	1	4	1.5	34009	482.-

### Art.: BExpa Plus 8 bis 50 Liter



- Druckgeräterichtlinie 97/23/CE
- geeignet für Trinkwasser DIN 1988
- Betriebstemperatur von -10 bis +100 °C
- Material Gefäss aus Edelstahl
- Material Membrane aus Butyl oder EPDM
- Finish poliert

Typ	Ø (mm)	Höhe (mm)	Anschluss 2x (Zoll)	Max. Druck (bar)	Vordruck (bar)	Art.Nr.	CHF / Stk. 1.4404
BExpa Plus 8	200	340	¾	10	2	34010	270.-
BExpa Plus 12	270	290	¾	10	2	34011	276.-
BExpa Plus 18	270	390	¾	10	2	34012	297.-
BExpa Plus 24	270	520	¾	8	2	34013	312.-
BExpa Plus 50	365	560	¾	4	1.5	34014	513.-



## Trinkwasserschlauch

### Art.: Trinkwasserschlauch TUN



DN	Innen-Ø (mm)	Aussen-Ø (mm)	Betriebsdruck (bar)	Art.Nr.	CHF / Stk.
4	6	10.5	20	34101	<b>Auf Anfrage</b>
6	7.5	11.5	20	34102	
8	9.5	14	15	34103	
10	12	17	15	34104	
13	15.3	21.5	15	34105	
20	20	28	10	34106	
25	25	30	10	34107	
32	32	43	10	34108	
40	40	52	10	34109	

Länge und Anschlüsse frei wählbar. (Nippel, Bogen, Überwurfmutter)

Bestellbeispiel: DN 13 es: ÜM ¾“, as: AG ½“ 90°, L: 1'000 mm

→ Schlauch Ø 13 mm, eine Seite Überwurfmutter ¾“ und andere Seite Nippel ½“ mit Bogen 90°, Länge 1'000 mm

## 4. Rohrkonsolen aus Edelstahl, schwere Ausführung

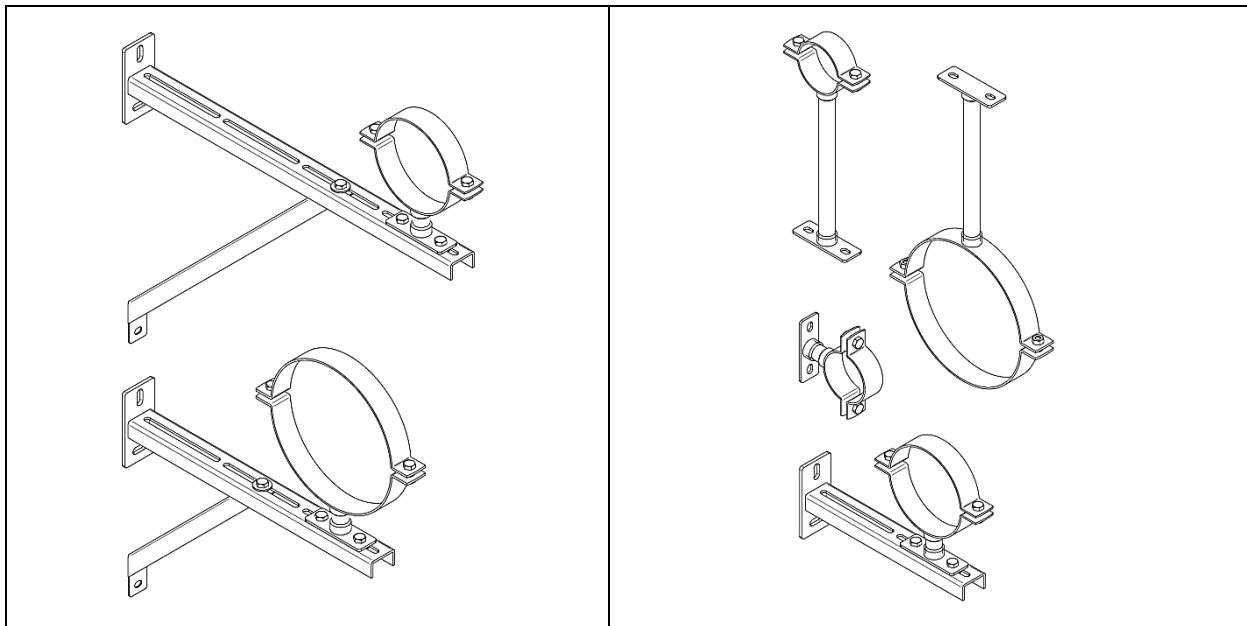

### Art.: Rohrschellen

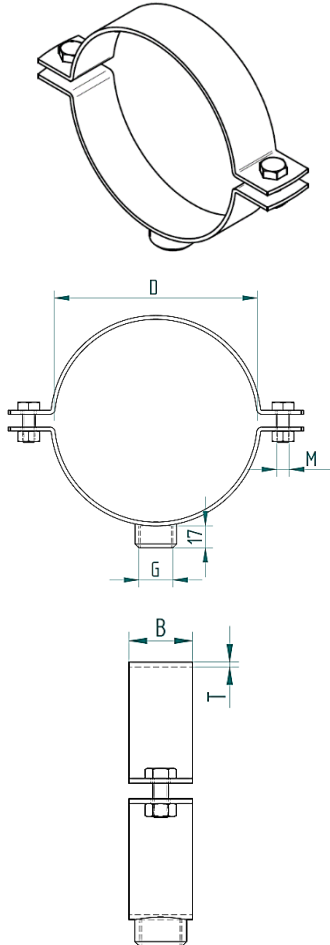
	DN	Breite B (mm)	Muffe G (Zoll)	Stärke T (mm)	Art.Nr.	CHF / Stk. 1.4404
	10 ... 15	25	1/2	2	44201	8.40
16 ... 19	25	1/2	2	44202	8.90	
20 ... 23	25	1/2	2	44203	9.50	
25 ... 26.9	25	1/2	3	44204	9.70	
28 ... 33.7	25	1/2	3	44205	11.10	
35 ... 38	25	1/2	3	44206	11.40	
40 ... 44.5	30	1/2	3	44207	12.20	
45 ... 50	30	1/2	3	44208	12.-	
53 ... 54	40	1/2	3	44209	16.30	
57 ... 60.3	40	1/2	3	44210	17.60	
69 ... 70	40	3/4	3	44211	18.90	
74 ... 76.1	40	3/4	3	44212	18.90	
83 ... 84	40	3/4	3	44213	21.60	
88.9	40	3/4	3	44214	21.60	
103 ... 106	40	3/4	3	44215	24.30	
114.3	40	3/4	3	44216	25.70	
128 ... 131	40	3/4	3	44217	25.70	
139.7	40	3/4	3	44218	27.-	
153 ... 156	40	3/4	3	44219	29.80	
168.3	40	3/4	4	44220	31.10	
203 ... 206	40	3/4	4	44221	51.40	
219.1	40	3/4	4	44222	54.10	
253 ... 256	40	3/4	4	44223	62.20	

**Art.: Rohrschellen**

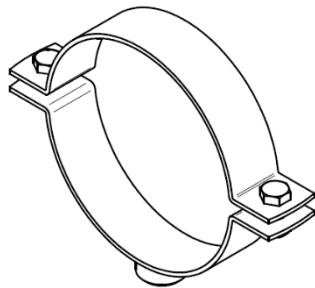

DN	Breite B (mm)	Muffe G (Zoll)	Stärke T (mm)	Art.Nr.	CHF / Stk. 1.4404
273	40	¾	4	44301	<b>63.50</b>
303 ... 306	50	¾	4	44302	<b>78.50</b>
323.9	50	¾	4	44303	<b>79.80</b>
353 ... 356	50	¾	4	44304	<b>112.-</b>
404 ... 406	50	¾	4	44305	<b>122.-</b>
454 ... 456	50	¾	4	44306	<b>138.-</b>
504 ... 508	50	¾	4	44307	<b>160.-</b>
604 ... 610	50	¾	4	44308	<b>302.-</b>

**Dazu passend: Kunststoffeinlegeband:  
Rolle à 10 m → CHF 21.70**

**Art.: Grundplatten**

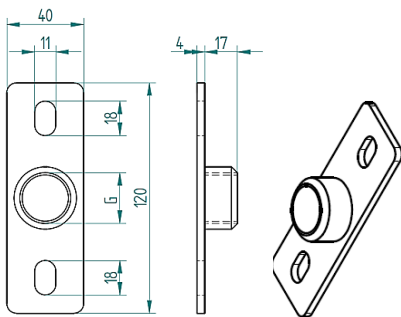

G (Zoll)	Ø (mm)	Art.Nr.	CHF/ Stk. 1.4301	Art.Nr.	CHF / Stk. 1.4404
½	bis 50	44309	<b>6.55</b>	44310	<b>9.20</b>
¾	ab 50	44311	<b>7.-</b>	44312	<b>9.90</b>

**Art.: Konsolen**

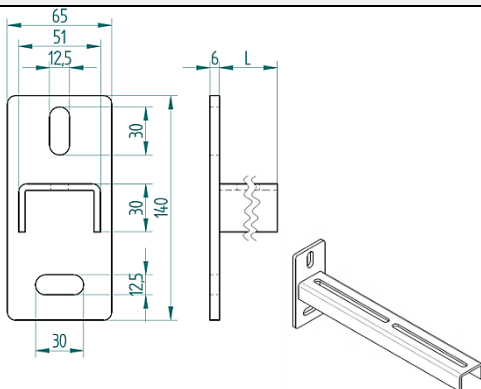

Länge L (mm)	Art.Nr.	CHF/ Stk. 1.4301	Art.Nr.	CHF / Stk. 1.4404
360	44313	<b>21.-</b>	44314	<b>29.40</b>
530	44315	<b>26.15</b>	44316	<b>36.50</b>
700	44317	<b>31.30</b>	44318	<b>43.80</b>

**2-Loch-Platten und Schienen à ~2 m auch einzeln erhältlich**

**Art.: Stützen für Konsolen**

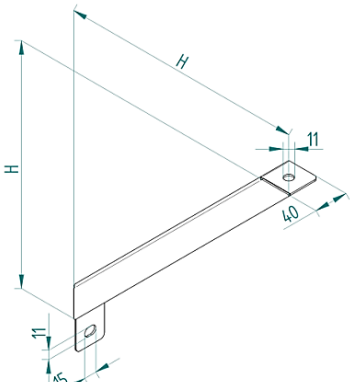
	Typ	Grösse (mm)	Art.Nr.	CHF/ Stk. 1.4301	Art.Nr.	CHF / Stk. 1.4404
	Klein	290	44401	16.80	44402	18.50
	Gross	460	44403	20.60	44404	22.60

## 5. Pumpen

### Art.: TPA Edelstahl-Kreiselpumpe „selbstansaugend“

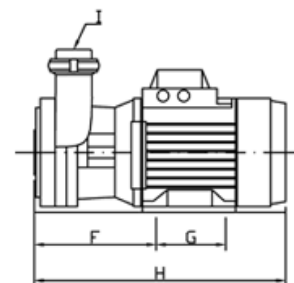
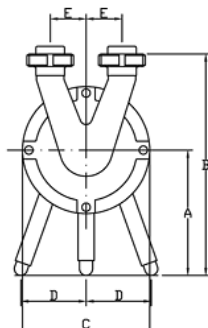
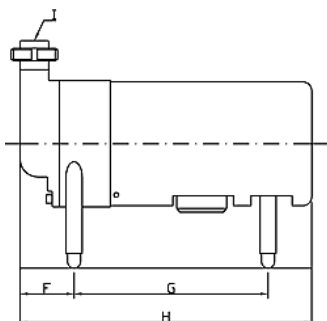

Typ	kW	Min <sup>-1</sup>	Länge H (mm)	Höhe B (mm)	Höhe A (mm)	Anschluss (DN)	Art.Nr.	CHF / Stk.
CSA5	0.5	1'400	335	195	80	32	54501	2'725.-
TPA11	1.1	1'400	490	213	210	40	54502	5'320.-
TPA15	1.5	1'400	490	213	210	40	54503	6'017.-
TPA22	2.2	1'400	550	262	210	50	54504	6'502.-
TPA30	3	1'400	550	262	210	50	56505	7'270.-

Detaillierte Massblätter auf Anfrage erhältlich

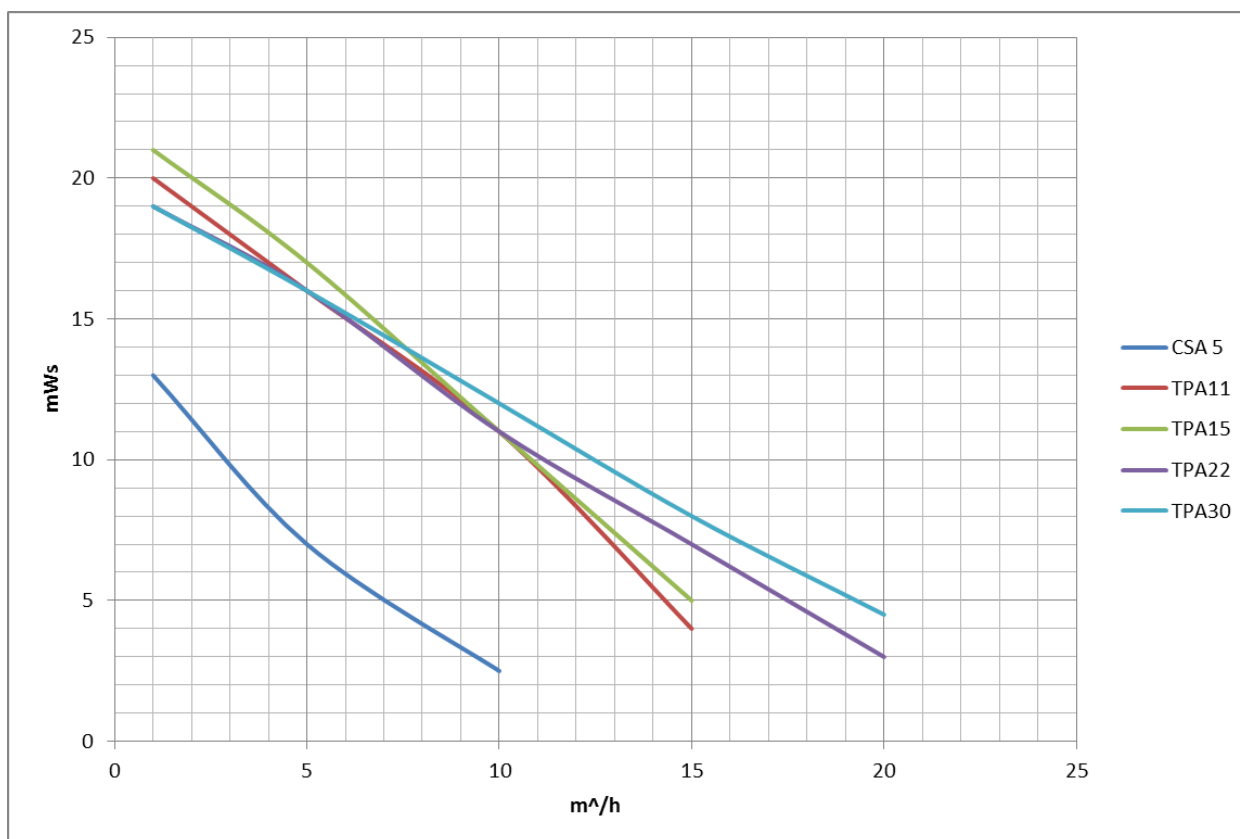

**Art.: FCE Edelstahl-Zentrifugalpumpen „zulaufend“**

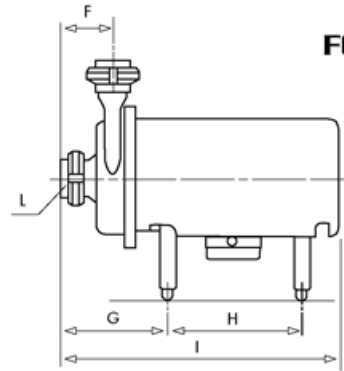
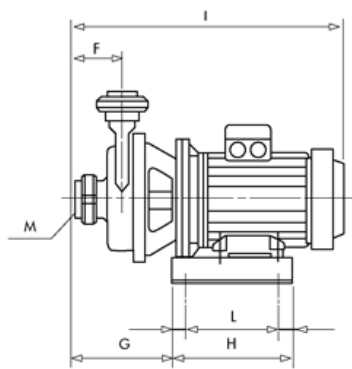

**FCE/FC**

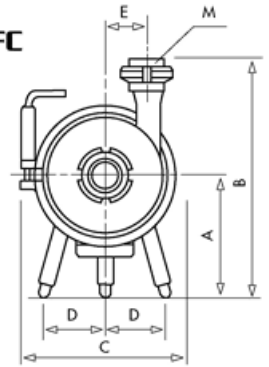

Typ	kW	Min <sup>-1</sup>	Länge l (mm)	Höhe B (mm)	Höhe A (mm)	Anschluss (DN)	Art.Nr.	CHF / Stk.
FCE11	1.1	2'800	465	395	210	50/50	54601	4'060.-
/B	1.1	2'800	425	310	125	50	54602	3'854.-
FCE15	1.5	2'800	505	395	210	50/50	54603	4'321.-
/B	1.5	2'800	440	320	135	50	54604	4'114.-
FCE22	2.2	2'800	505	395	210	50/50	54605	4'841.-
/B	2.2	2'800	470	320	135	50	54606	4'611.-
FC30	3	2'800	470	430	210	65/50	54607	5'651.-
/B	3	2'800	570	385	125	50	54608	4'871.-
FC40	4	2'800	570	430	210	65/50	54609	6'012.-
FC55	5.5	2'800	595	430	210	65/50	54610	8'535.-
FC75	7.5	2'800	595	430	210	65/65	54611	8'813.-

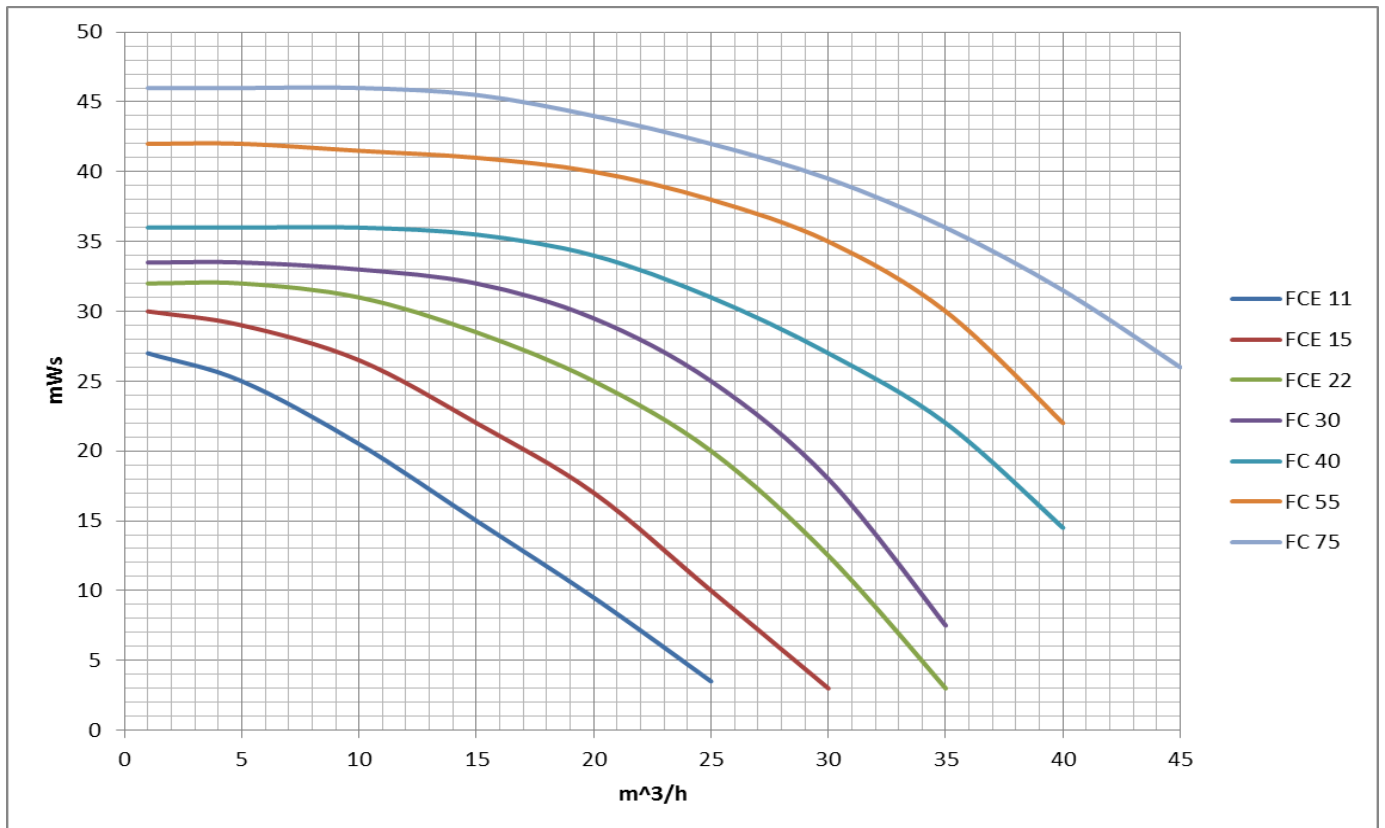

**Art.: Lowara CEA-Kreiselpumpen für Kalt- und Heisswasser bis 110°C**

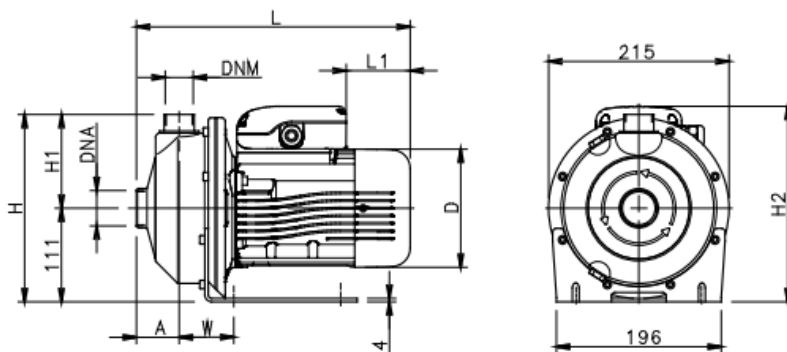

Typ	kW	l/min	Länge L (mm)	Höhe H (mm)	Höhe H2 (mm)	Anschluss (DNA/DNM)	Art.Nr.	CHF / Stk.
CEA 70/3	0.37	30 - 80	311	222	222	1 ¼" / 1"	54701	652.-
CEA 70/5	0.55	30 - 80	325	222	232	1 ¼" / 1"	54702	692.-
CEA 120/3	0.55	60 - 160	325	222	232	1 ¼" / 1"	54703	831.-
CEA 120/5	0.90	60 - 180	325	222	241	1 ¼" / 1"	54704	865.-
CEA 210/3	1.10	120 - 300	385	224	248	1 ½" / 1 ¼"	54705	944.-
CEA 210/5	1.85	120 - 300	429	224	262	1 ½" / 1 ¼"	54706	1'043.-
CEA 370/3	1.85	200 - 500	429	224	262	2" / 1 ¼"	54707	1'091.-

**Weitere Modelle auf Anfrage erhältlich.  
Typ CA für höhere Drücke und Typ CO mit offenem Laufrad**

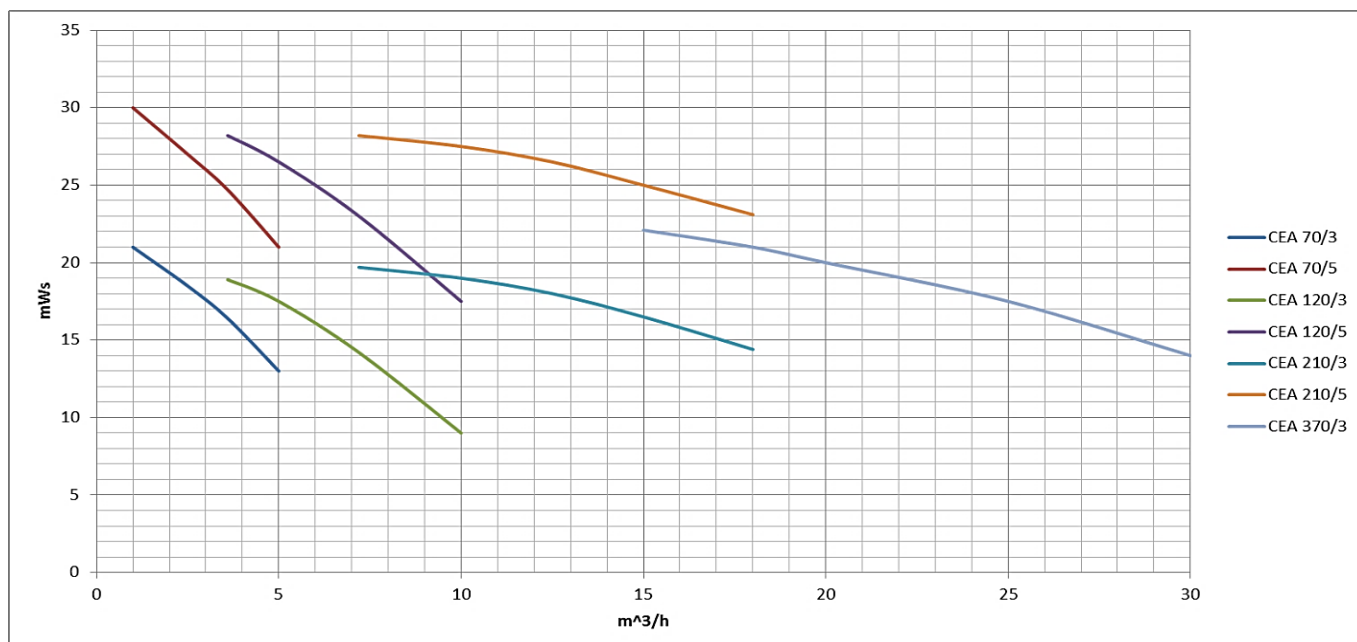

**Art.: Gleitringdichtungen kpl.**

	Typ	Zu Pumpentyp	Art.Nr.	CHF / Stk.
	WD 19 KK	CSA5, CPA5, TPA5, TPA7	54801	<b>206.-</b>
	WD 20 KH	ZA10, ZC10, ZC15	54802	<b>190.-</b>
	WD 24 KK/KH	TPA11-15, TCP7-22, FCE11-22	54803	<b>251.-</b>
	WD 25 KH	ZA15, ZC20-40	54804	<b>199.-</b>
	WD28KK/KH	TPA22-30, TCP30-55, FC30-25, TPS22-40	54805	<b>299.-</b>
	WD30KK/KH	ZA25-55, ZC55-200	54806	<b>326.-</b>
	WD32KK	TPS55	54807	<b>359.-</b>
	WD35KH	ZA75	54808	<b>242.-</b>
	Kohlering einzeln			54809
Keramikring einzeln			54810	<b>122.-</b>
Feder			54811	<b>17.80</b>
Gehäusedichtung 3.0 – 3.53 mm			54812	<b>21.80</b>
Gehäusedichtung 7.0 mm			54813	<b>35.50</b>



## 6. Waschröge und Spültische

Art.: Waschtrog						
	Länge (mm)	Breite (mm)	Tiefe (mm)	Höhe m. Untergestell und Rollen (mm)	Art.Nr.	CHF / Stk. 1.4404
		960	680	350	920	64901
	Wandkonsolen passend zu Waschtrog				64902	252.-
	Untergestell m. 2 Bock- und Lenkrollen				64903	1'097.-
	Einlagerost				64904	369.-
	Brühtrog (Masse wie Waschtrog) mit Doppelmantel 3 bar druckbeständig				64905	3'329.-

Art.: Spültisch						
	Länge (mm)	Breite (mm)	Tiefe (mm)	Anschluss (DN)	Art.Nr.	CHF / Stk. 1.4404
		680	545	28	50	64906

→ Sonderanfertigungen auf Anfrage möglich!